



Sheer  
Driving Pleasure



THE NEW BMW X3 M.  
THE NEW BMW X4 M.







THE NEW BMW X3 M.  
THE NEW BMW X4 M.



18 Highlights



23 Exterior colour world



24 Interior colour world

## DIGITAL DISCOVERY: THE NEW BMW BROCHURES APP.

More information, more driving pleasure: The new BMW brochures app offers you a brand new digital and interactive BMW experience. Download the BMW brochures app for your smartphone or tablet now and explore new perspectives of your BMW.

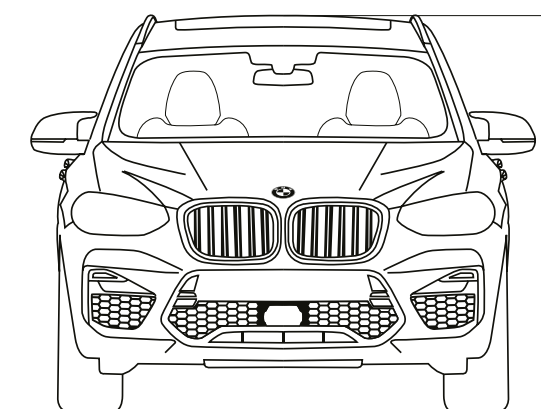

26 Technical data





COMPLETE.  
EXTREME.





POSTURE.  
EVEN IN FULL DRIVE.





GOOSEBUMPS DON'T LIE.







HITS THE PULSE OF THE TIMES.  
AND TICKLES IT.











UNTAMED. BUT UNDER  
COMPLETE CONTROL.

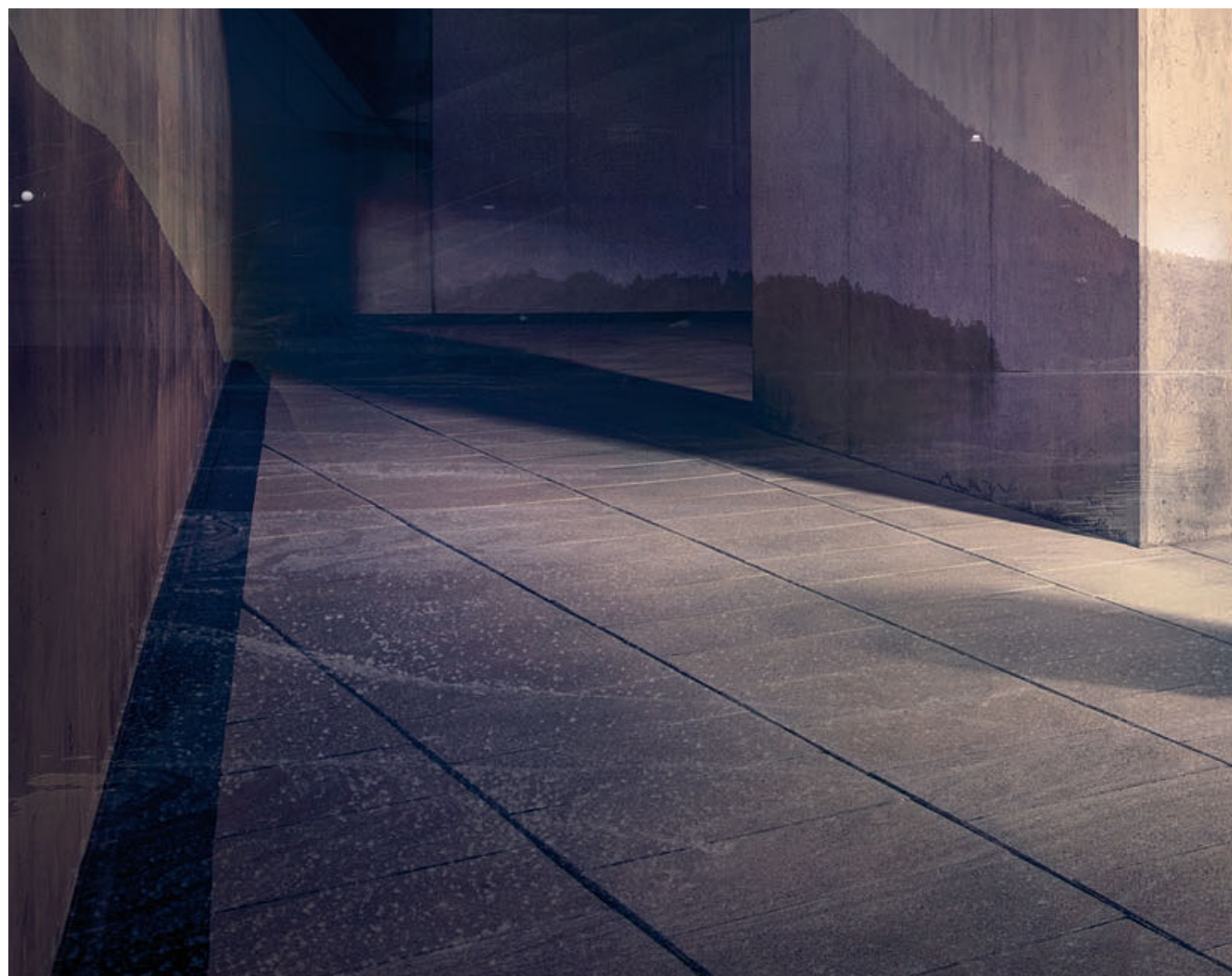



NO BUT.  
RATHER NOW MORE THAN EVER.



**The first M models in their segment – self-confident and powerful** marked double kidney grille and powerful air intakes /// athletic-powerful proportions and broad stance /// big 21" M light alloy wheels V-spoke style 765 M Bicolour Black with mixed tyres. **M specific design for an interior with racing character and highest control** M leather steering wheel with M1/M2 buttons /// Interior trim finishers , Carbon Fibre<sup>1</sup> /// M Sport seats in leather ,Merino' with extended contents and illuminated M logo. **Enormous performance values** Competition model with 375 kW (510 hp) newly developed M TwinPower Turbo engine /// in 4.1 seconds from 0–100 km/h /// M specific xDrive /// Active M differential /// M specific suspension /// M Sport exhaust system. **Daily routine out. Adrenaline in. The new BMW X3 M Competition and BMW X4 M Competition.**

<sup>1</sup> Available as optional equipment.



# HIGHLIGHTS.

Discover even more with the new BMW Brochures app. Available now, for your smartphone and tablet.

■ Standard equipment □ Optional equipment



■ The X3 M Competition offers an increase in driving dynamics and a powerful, particularly emotional engine sound thanks to increased engine performance and M Sport exhaust system with black chrome twin tailpipes. Distinctive exterior details in Black, the exclusive 21" M light alloy wheels and M Sport seats in leather Merino underline the sporty character.



■ The M specific suspension highlights the vehicle's great dynamic potential. In addition to the three driving modes COMFORT, SPORT and SPORT+, the driver can also choose between three different Dynamic Stability Control (DSC) settings in order to adapt the level of stabilising support to suit their preferred style of driving.



■ The high-performance M TwinPower Turbo inline 6-cylinder petrol engine features superior power delivery and silky-smooth running coupled with a sporty engine sound. With Double-VANOS, Valvetronic, High-Precision Injection and two turbocharger, it generates 353 kW (480 hp) – in the Competition model even 375 kW (510 hp).



■ The specific model designation of the new BMW X3 M Competition is located below the climate control unit and in a visual extension of the M specific gear selector.<sup>3</sup>



□ The M seat belts<sup>1,2,4</sup> with belt tensioner and belt force limiter have a finely woven-in accent in the typical M colours.



□ The multi-adjustable M Sport seats<sup>1</sup> with bucket seat character and partly integrated headrest provide excellent lateral support for the driver and front passenger. In addition, the backrest width can be individually adjusted. Their special design with illuminated M logo highlights the vehicle's athletic capabilities.



□ The M Carbon precision<sup>2</sup> strut increases frontend rigidity and contributes to a greater steering precision and accuracy. The premium quality carbon fibre reinforced polymer component is extremely lightweight and creates a genuine motor sport atmosphere when the bonnet is up. In this way, the sporty potential is also expressed particularly well here.



□ The M Sport exhaust system<sup>1</sup> delivers a dynamic sound that can be modified via the integrated exhaust valve mechanism. The SPORT and SPORT+ programmes, which can be selected via the Driving dynamics buttons, are accentuated by an even more intense engine sound, while the comfort-oriented programme prioritises more discreet engine acoustics.



■ Above the right full-LED rear light, the M model designation with Competition Badge<sup>3</sup> sets an unmistakable sign for dynamism and pure power.



The driver and front passenger are welcomed by door sill finishers with the "X3 M Competition" designation as soon as they get in. The designation on the inserts in Black the door sill finishers in the front on the left and right radiates quality and exclusivity.



■ 20" M light alloy wheels Double-spoke style 764 M in Bicolour Orbit Grey with mixed tyres, gloss-lathed, front wheel size 9J x 20, 255/45 ZR120 tyres, rear wheel size 10J x 20, 265/45 ZR20 tyres.



□ 21" M light alloy wheels V-spoke style 765 M Bicolour Orbit Grey with mixed tyres, gloss-lathed, front 9.5J x 21 with 255/40 R21 tyres, rear 10J x 21 with 265/40 R21 tyres.<sup>1</sup>



■ 21" M light alloy wheels V-spoke style 765 M in Bicolour Black with mixed tyres, gloss-lathed, front wheel size 9.5J x 21, 255/40 ZR21 tyres, rear wheel size 10J x 21, 265/40 ZR21 tyres.<sup>3</sup>

<sup>1</sup> Part of the Competition models.  
<sup>2</sup> Available from 08/2019.  
<sup>3</sup> Only available for Competition models.  
<sup>4</sup> Only available in conjunction with additional equipment.



# HIGHLIGHTS.

Discover even more with the new BMW Brochures app. Available now, for your smartphone and tablet.

■ Standard equipment □ Optional equipment



□ The Adaptive LED headlights include low-beam and high-beam headlights and turn indicators with full LED technology. The equipment also features BMW Selective Beam, cornering lights, daytime running lights and Adaptive headlights with variable light control for excellent illumination of the road ahead and better visibility in the dark.



■ Thanks to the use of various materials, M compound brakes achieve outstanding deceleration values and are extremely stable and highly durable. They also weigh less, which has a positive impact on agility, dynamics and acceleration. The Blue metallic brake callipers with the M designation are the hallmark of these high-performance M specific brakes.



■ The red Start/Stop button allows the engine to be started without using the key once the vehicle has been unlocked. It can also be used to stop the engine. The vehicle key is recognised automatically, without having to insert it.



■ The M leather steering wheel including multifunction buttons, the M badge, chrome detailing and an integrated driver-side airbag has the Double-spoke design. Featuring a steering wheel rim in black leather with colour contrast stitching and contoured thumb rests, it feels great in the hand. The driver can also use the M Drive buttons to select the desired settings whilst driving.



□ The BMW Display Key with M logo displays various vehicle status data and allows selected functions to be operated via the integrated touch display.



□ Harman Kardon surround sound system<sup>1</sup> with 600 watt digital amplifier, vehicle-specific equalising and loudspeakers with chrome detailing.



■ The individually adjustable Sport seats with an embossed M logo for the driver and front passenger feature numerous adjustment options, including backrest width, fore-and-aft position, and the backrest and seat angle. Thanks to taller seat and backrest bolsters, and well-defined side bolsters, they provide excellent ergonomics and a high degree of lateral support.



■ The M gear selector switch features a M specific switch pattern. In manual „S“ mode, the driver can shift gears manually using the selector lever or the rocker switch on the steering wheel in typical M fashion; in „D“ mode, shifting occurs automatically. Whereas the Drivelogic switch for the three shifting programs is on the upper side, the P button for the parking lock is placed under the M logo.

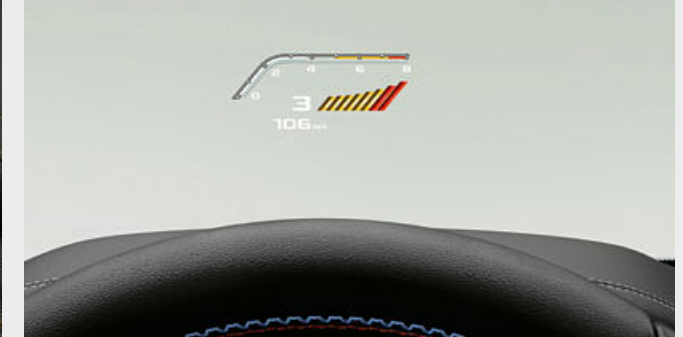

□ The full-colour BMW Head-Up Display<sup>2</sup> incl. M specific display projects information relevant to the journey directly into the driver's field of vision, thereby allowing them to fully concentrate on driving. Information such as the current speed and, depending on the equipment, navigation directions, Speed Limit Info including no-overtaking indicator, along with telephone and entertainment lists are displayed.



■ The aerodynamically optimised M exterior mirrors are a significant part of the sporty and dynamic M design. Attached to the body by an indicated double-bridge design, they underscore the beautiful aesthetics of the vehicle and convey a sense of precision engineering down to the last detail. The additional LED indicators are fitted perfectly into a long, narrow groove.



■ The M specific roof spoiler with its prominent shape ensures more downforce on the rear axle at higher speeds. At the same time, it lends the three-quarter rear view characteristic sportiness and promises highly dynamic driving experiences.



□ The Navigation system Professional<sup>3</sup> incl. 10.25" LCD colour display and Radio BMW Professional with DVD drive comes with more than 20 GB of memory e.g. for audio files. It is operated intuitively via the iDrive Touch Controller and seven functional bookmarks or alternatively via the Touch Display.

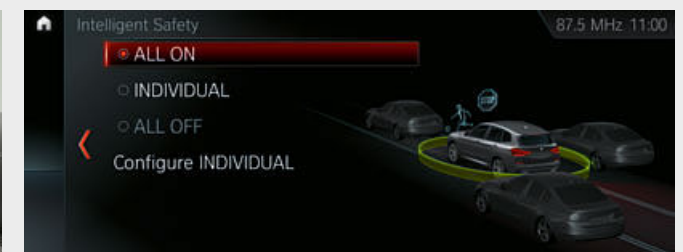

□ Driving Assistant Plus<sup>1-4</sup> offers greater comfort and security during monotonous or complex driving situations. These can include traffic jams, stop-and-go traffic or long journeys through the city, on country roads or motorways, along with navigating junctions and lane changes.

Some ConnectedDrive Services may differ between countries. Please consult your local BMW partner for more information. The Standard and Optional equipment may differ between countries. Please consult your local BMW partner for more information.

<sup>1</sup> Only available in conjunction with additional equipment.

<sup>2</sup> The information in the BMW Head-Up Display is not fully visible when viewed through polarised sunglasses. Content shown will depend on the equipment options chosen. Further optional equipment is required to display specific items.

<sup>3</sup> As part of BMW ConnectedDrive, in selected European countries the system automatically updates domestic maps up to four times per year, for a period of three years.

<sup>4</sup> Function may be limited in darkness, fog or bright glare.



# M CARBON PACKAGE FOR THE EXTERIOR.

# EXTERIOR COLOUR WORLD.

Discover even more with the new BMW Brochures app. Available now, for your smartphone and tablet.

■ Standard equipment □ Optional equipment



□ The M specific carbon-fibre rear spoiler provides more contact pressure on the rear axle at higher speeds. At the same time, it lends the rear view characteristic sportiness and promises highly dynamic driving experiences.<sup>1,2</sup>



□ M specific carbon-fibre mirror caps intensify the distinctive sporty character of the new BMW X4 M Competition.<sup>1,2</sup>



□ Below the outer air intakes, aeroblades emphasise the sporty and exclusive appearance of the front.<sup>1,2</sup>



□ The strikingly designed rear diffuser made of carbon fibre frames the two tailpipes and sets a self-confident sign in the rear view. Further details make an effective contribution to this: An M specific rear apron and a characteristic honeycomb look below the number plate create an impressive overall picture that makes BMW M noticeable in every detail.<sup>1,2</sup>

## BMW INDIVIDUAL

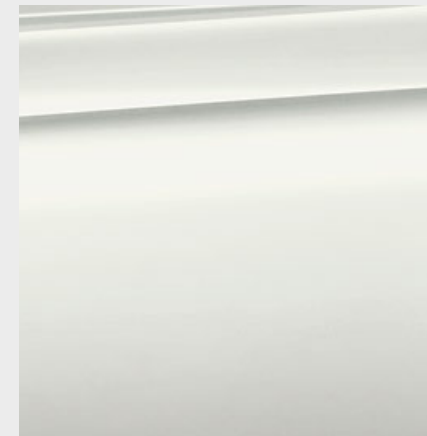

■ Non-metallic 300 Alpine White

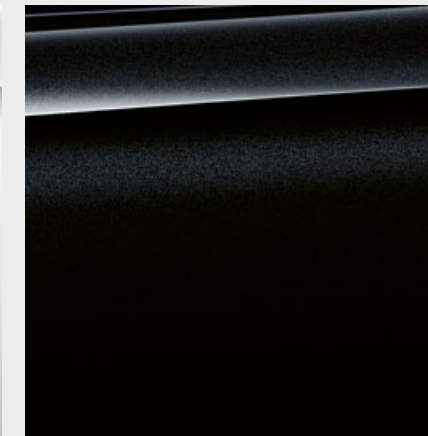

□ Metallic 475 Black Sapphire



□ BMW Individual C1N Sunstone metallic



□ Metallic A90 Sophisto Grey Brilliant Effect

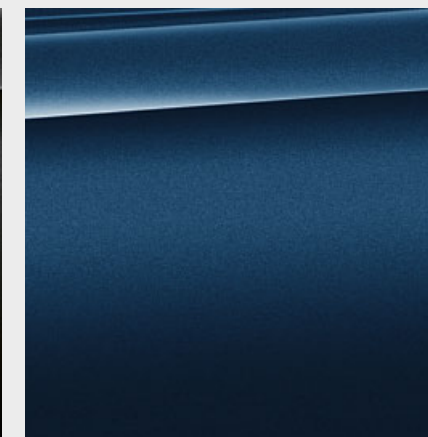

□ Metallic C1M Phytomic Blue

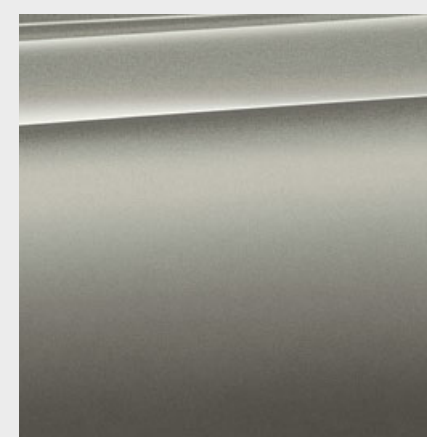

□ Metallic C28 Donington Grey

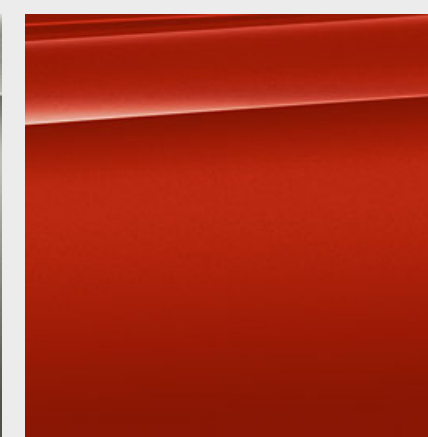

□ Metallic C3G Toronto Red

The Standard and Optional equipment may differ between countries. Please consult your local BMW partner for more information.

<sup>1</sup> Part of the M Carbon exterior package.

<sup>2</sup> Planned availability: 08/2019.

**[Colour samples]** These colour samples are intended as an initial guide to the colours and materials available for your BMW. However, experience has shown that printed versions of paint, upholstery and interior trim colours cannot in all cases faithfully reproduce the appearance of the original colour. Please discuss your preferred colour choices with your BMW partner or in your dealership. There you can also see original samples and be assisted with special requests.



# INTERIOR COLOURS.

Discover even more with the new BMW Brochures app. Available now, for your smartphone and tablet.

■ Standard equipment □ Optional equipment



## LEATHER

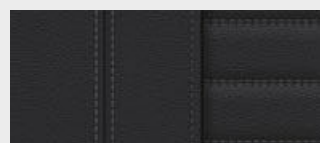

■ Leather 'Vernasca' MAH7 Black decor stitching

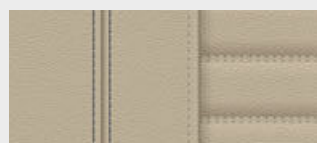

■ Leather 'Vernasca' MAOQ Oyster decor stitching with extended contents

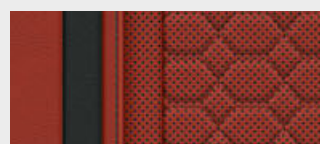

□ Leather 'Merino' LKDA with extended contents Sakhir Orange, with highlight in Black<sup>2,3</sup>

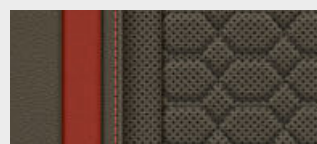

□ Leather 'Merino' LKHV with extended contents Adelaide Grey, with highlight in Sakhir Orange<sup>2,3</sup>

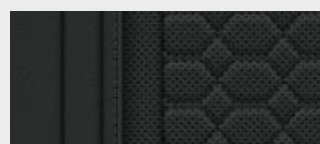

□ Leather 'Merino' LKSW with extended contents Black<sup>2,3</sup>

## BMW INDIVIDUAL UPHOLSTERY COLOURS



□ BMW Individual extended leather trim 'Merino' VAEW Ivory White<sup>2,3</sup>

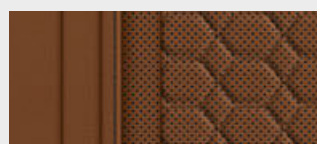

□ BMW Individual extended leather trim 'Merino' VATQ Tartufo<sup>2,3</sup>

## LEATHER-ALCANTARA COMBINATION

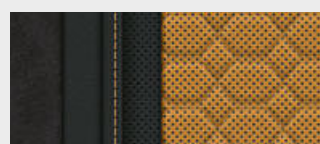

□ Leather/Alcantara combination HDJA Black, contrast stitching Midrand Beige<sup>1</sup>

## INTERIOR TRIM



■ Interior trim finishers Aluminium Carbon Texture on the instrument panel, doors and centre console with highlight trim finisher Pearl Chrome.

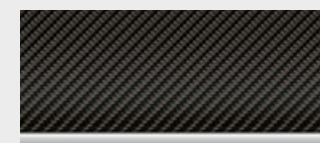

□ Interior trim finishers 'Carbon Fibre' on the instrument panel, doors and centre console with highlight trim finisher Pearl Chrome.

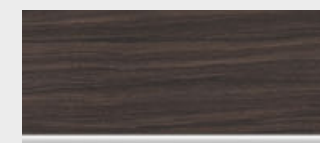

□ Open-pored fine-wood trim, 'Fineline' Cove on the instrument panel, centre console and doors with highlight trim finisher Pearl Chrome.

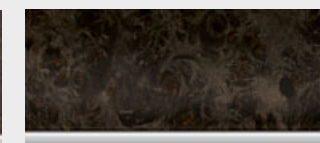

□ Fine-wood trim poplar grain grey with highlight trim finisher Pearl Chrome.

## BMW INDIVIDUAL INTERIOR TRIM FINISHERS



□ BMW Individual interior trim finishers piano finish Black on the instrument panel, doors and centre console with highlight trim finisher Pearl Chrome.<sup>2,3</sup>

<sup>1</sup> Only available for Competition models.

<sup>2</sup> Available as standard for M Competition models.

<sup>3</sup> Only available in conjunction with M Sport seats.

The Standard and Optional equipment may differ between countries. Please consult your local BMW partner for more information.

Please note that even normal long- or short-term use can lead to unrecoverable upholstery damage. This can be caused in particular by non-colourfast clothing.

Please note that the interior colour depends on the selected upholstery colour.



		<b>X3 M</b>	<b>X4 M</b>	<b>X3 M Competition</b>	<b>X4 M Competition</b>
--	--	-------------	-------------	-------------------------	-------------------------

<b>Weight</b>					
Unladen weight EU <sup>1</sup>	kg	2045	2045	2045	2045
Maximum permissible weight	kg	2500	2500	2500	2500
Permitted load	kg	530	530	530	530
Permitted trailer load, unbraked <sup>2</sup>	kg	750	750	750	750
Permitted trailer load, braked, max. 12% gradient/max. 8% gradient <sup>2</sup>	kg	2500/2500	2500/2500	2500/2500	2500/2500
Luggage capacity	l	550	525	525	525

<b>M TwinPower Turbo engine<sup>5</sup></b>					
Cylinders/valves		6/4	6/4	6/4	6/4
Capacity	cm <sup>3</sup>	2993	2993	2993	2993
Max. output/engine speed	kW (hp)/rpm	353 (480)/6250	353 (480)/6250	375 (510)/6250	375 (510)/6250
Max. torque/engine speed	Nm/rpm	600/2600–5600	600/2600–5600	600/2600–5950	600/2600–5950

<b>Power transmission</b>					
Type of drive		M xDrive	M xDrive	M xDrive	M xDrive
Standard transmission		M Steptronic transmission	M Steptronic transmission	M Steptronic transmission	M Steptronic transmission

<b>Performance</b>					
Top speed	km/h	250 <sup>3</sup>	250 <sup>3</sup>	250 <sup>3</sup>	250 <sup>3</sup>
Top speed with optional M Driver's Package <sup>4</sup>	s	280	280	285	285
Acceleration 0–100 km/h	s	4,2	4,2	4,1	4,1

<b>Fuel consumption<sup>5,6</sup></b>					
Combined	l/100 km	11.1–11.6	11.1–11.5	– <sup>7</sup>	– <sup>7</sup>
Exhaust emissions standard (type-certified)		EU6d-temp	EU6d-temp	EU6d-temp	EU6d-temp
Combined CO <sub>2</sub> emissions	g/km	254–264	252–263	– <sup>7</sup>	– <sup>7</sup>
Tank capacity, approx.	l	65	65	65	65

<b>Wheels/tyres</b>					
Tyre dimensions		255/45 ZR 20 265/45 ZR 20	255/45 ZR 20 265/45 ZR 20	255/40 ZR 21 265/40 ZR 21	255/40 ZR 21 265/40 ZR 21
Wheel size		9J x 20 10J x 20	9J x 20 10J x 20	9,5J x 21 10J x 21	9,5J x 21 10J x 21
Material		Light alloy	Light alloy	Light alloy	Light alloy

## BMW X3 M

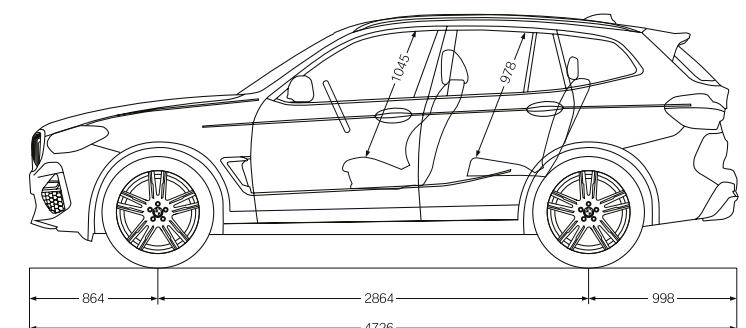
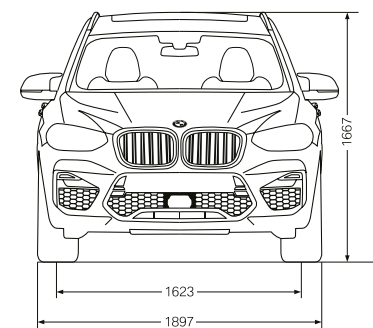

## BMW X4 M

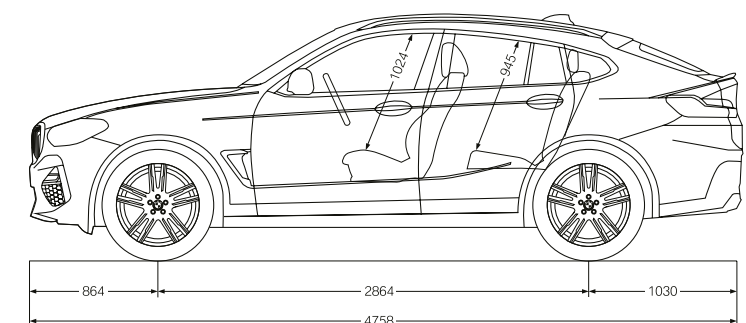
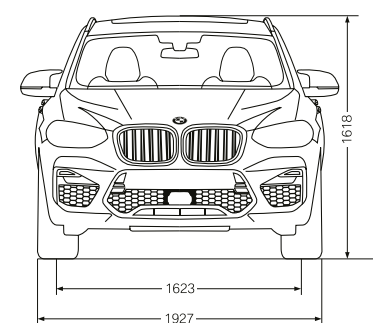

Different height for Competition models: BMW X3 M Competition 1669 mm, BMW X4 M Competition 1620 mm.

<sup>1</sup> The EC unladen weight refers to a vehicle with standard equipment and does not include any optional extras. The unladen weight includes a 90% full tank and a driver weight of 75 kg. Optional equipment may affect the weight of the vehicle, the payload and the top speed if the selected equipment has an impact on the vehicle's aerodynamics.  
<sup>2</sup> The actual total weight of the trailer must not exceed the maximum permitted trailer load, taking into account the maximum tow bar download.  
<sup>3</sup> Electronically limited.  
<sup>4</sup> The raised top speed is only available after the first service following the 2,000 km run-in period.  
<sup>5</sup> Performance data of petrol engines apply to vehicles using RON 98 fuel. Fuel consumption data apply to vehicles using reference fuels in accordance with EU Regulation 2007/715. Unleaded RON 91 and higher with a maximum ethanol content of 10% (E10) may also be used. BMW recommends RON 98 super plus unleaded petrol.  
<sup>6</sup> The data for fuel consumption, CO<sub>2</sub> emissions and energy consumption are determined in accordance with the measurements processes as defined by European Regulation (EU) 2007/715 in the applicable version. Data refer to a vehicle with base-level equipment in Germany, and the ranges account for differences according to the selected wheel and tyre size and the optional equipment and may change during the configuration process. Figures have been determined on the basis of the new WLTP test cycle. [For these vehicles, values other than those specified here may apply for the assessment of taxes and other vehicle-related charges that are (also) based on CO<sub>2</sub> emissions.]  
<sup>7</sup> This engine version is not available in all countries. Please contact your local BMW partner for more information.



**BMW X3 M Competition:**

M TwinPower Turbo 6-cylinder petrol engine, 375 kW (510 hp), 21" M light alloy wheels V-spoke style 765 M Bicolour Black with mixed tyres, exterior colour in Donington Grey metallic, M Sport seats in leather/Alcantara combination Black with contrast in Midrand Beige, interior trim finishers ,Carbon Fibre'.

**BMW X4 M Competition:**

M TwinPower Turbo 6-cylinder petrol engine, 375 kW (510 hp), 21" M light alloy wheels V-spoke style 765 M Bicolour Black with mixed tyres, exterior colour in Toronto Red metallic, M Sport seats in leather ,Merino' with extended contents in Adelaide Grey, interior trim finishers ,Carbon Fibre', M Carbon exterior package.

The models illustrated in this brochure show the equipment and configuration options (standard and optional) for vehicles produced by BMW AG for the German market. Alterations in standard and optional equipment and the configurations available for the different models, as described in this brochure, may occur after 03/01/2019, the date when this brochure went to press, or according to the specific requirements of other markets. Your local BMW Partner is available to provide further details. Subject to change in design and equipment.

© BMW AG, Munich, Germany. Not to be reproduced wholly or in part without prior written permission of BMW AG, Munich.

4 11 015 127 36 1 2019 BC. Printed in Germany 2019.

