

# STAY CONNECTED

VISIT US ONLINE TO CREATE YOUR IDEAL INFINITI

[www.infinitiusa.com](http://www.infinitiusa.com)

JOIN OUR COMMUNITY, AND GET THE LATEST INFO

 [Facebook.com/infiniti](https://www.facebook.com/infiniti)

 [Instagram.com/infinitiusa](https://www.instagram.com/infinitiusa)

 [Twitter.com/infinitiusa](https://www.twitter.com/infinitiusa)

This brochure is intended for general descriptive and informational purposes only. It is subject to change and does not constitute an offer, representation or warranty (express or implied) by Nissan North America, Inc. Interested parties should confirm the accuracy of any information in this brochure as it relates to a vehicle directly with an INFINITI Retailer before relying on it to make a purchase decision. Nissan North America, Inc. reserves the right to make changes, at any time, without prior notice, in prices, colors, materials, equipment, specifications, and models and to discontinue models or equipment. Due to continuous product development and other pre- and post-production factors, actual vehicle, materials and specifications may vary from this brochure. Some vehicles shown with optional equipment. See the actual vehicle for complete accuracy. Availability and delivery times for particular models or equipment may vary. Specifications, options and accessories may differ in Hawaii, U.S. territories and other countries. For additional information on availability, options or accessories, see your INFINITI Retailer or visit INFINITI website.

Final production vehicle may vary. Always wear your seat belt, and please don't drink and drive. ©2021 INFINITI. IN-06472 Reorder #22506i (9/21, 10K, KSL) ♻️ Reducing our environmental footprint is an important goal at INFINITI. That's why this brochure uses paper stock that is certified to contain a minimum of 10% post-consumer waste materials.

2022

# Q60



INFINITI

# ENGINEERED TO LET INSTINCT TAKE THE LEAD



For those who are inspired by fearless forward progress, the Q60 is an advanced performance coupe that heightens your senses emotionally, and aesthetically. When the journey requires exhilarating power, you'll accelerate your way with a choice of a 300-hp or 400-hp twin-turbocharged V6 engine<sup>1</sup> that can charge forward and pass with confidence. When the twists and turns of the path ahead demand that you adapt, an INFINITI world's first Direct Adaptive Steering<sup>®</sup> system<sup>1</sup> makes cornering feel smooth and instinctual, while Dynamic Digital Suspension<sup>1</sup> can adjust to the road and the driver in real time to yield the best response for the moment. When standing out is non-negotiable, you'll exhibit daring curves and inspiring lines on city streets and beyond. This is luxury for a life lived in Drive.

**LUXURY SHOULD BE LIVED IN**

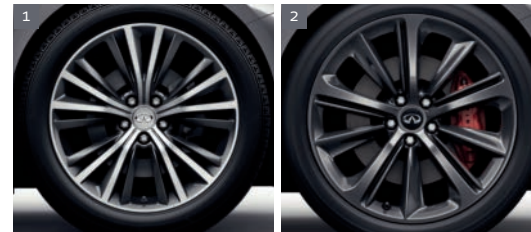

**^ ROLL WITH DISTINCTION** **1** 19 X 9.0-inch Aluminum-Alloy Wheels **2** 20 X 9.0-inch Front, 20 X 9.5-inch Rear Staggered Aluminum-Alloy Wheels\*\*\*



## **^ EVERY CURVE CAPTURES AN EMOTION**

The sight of a Q60 stirs something deep inside. You sense it when gazing upon its dramatic creases and distinctive shapes. You anticipate it when looking over its athletic stance. With a sleek body that stands low and wide, the Q60 conveys exciting performance. With the Q60 RED SPORT 400, select elements dial up its sporting presence. Wide, summer performance tires on 20-inch alloy wheels provide impressive levels of grip, while red brake calipers add some eye-catching flair.<sup>2</sup> Sports exhaust tips exit from the lower rear bumper and sing an engaging tune as the engine powers through its rev range.

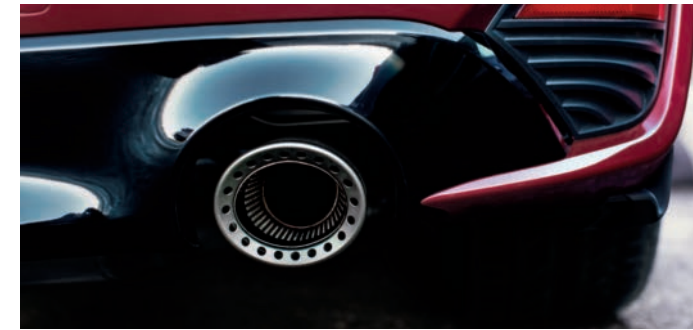

## **^ 300 HP OR 400 HP. EXHILARATION FROM THE START**

Press the Push Button Start and feel the power of a 3.0-liter twin-turbocharged V6 come to life. Featuring turbochargers designed to respond quickly to driver throttle input and a speed sensor<sup>1</sup> to help increase boost pressure, the engine in the RED SPORT 400 raises output from 300 hp to 400 hp.<sup>1</sup> The water-cooled air travels a short path to the engine so it stays more dense for more power – and an infinite rush.<sup>1</sup> The 7-speed automatic transmission can match engine RPMs to gear speeds for smooth downshifts.

\*INFINITI has taken care to ensure that the color swatches presented here are the closest possible representations of actual vehicle colors. Swatches may vary slightly due to the printing process and whether viewed in daylight, fluorescent or incandescent light. Please see the actual colors at your local INFINITI Retailer. \*\*Additional cost applies for this option. \*\*\*Q60 RED SPORT 400 AWD receives 20 x 9.0-inch front and rear wheels with all-season performance tires. Additional cost applies for this option.

## EXTERIOR COLORS\*

PURE WHITE (QAW)

MAJESTIC WHITE (QAB)\*\*

GRAPHITE SHADOW (KAD)

SLATE GRAY (KBZ)\*\*

DYNAMIC SUNSTONE RED (NBA)\*\*

GRAND BLUE (RCJ)\*\*

MIDNIGHT BLACK (GAG)\*\*

BLACK OBSIDIAN (KH3)

## **^ PAINT WITH PERSONALITY**

From sophisticated to dynamic, color inspires your own personal style.

#### INTERIOR COLOR/MATERIAL\*

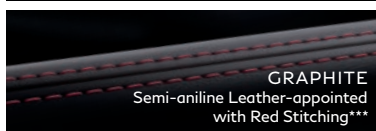
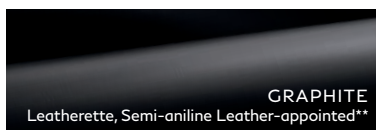
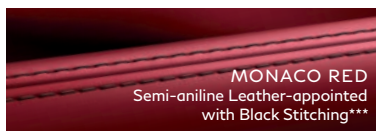
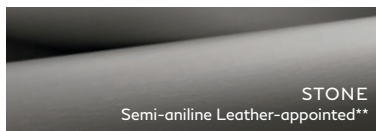
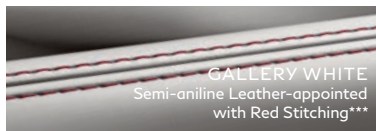

#### INTERIOR TRIM\*

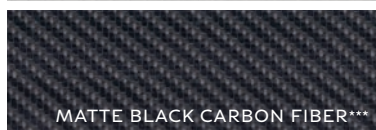

^ **EVERY CHOICE IS BOLD** A rich and modern palette is the foundation for a premium space. Engage the senses with a striking combination of sight and touch.

\*INFINITI has taken care to ensure that the color swatches presented here are the closest possible representations of actual vehicle colors. Swatches may vary slightly due to the printing process and whether viewed in daylight, fluorescent or incandescent light. Please see the actual colors at your local INFINITI Retailer. \*\*Additional cost applies for this option. \*\*\*Available on Q60 RED SPORT 400 only.



## FORM FIT TO PERFORM

Performance drivers know the feeling of a good pair of driving gloves – personal, fitted and above all, comfortable. This kind of tailored design and craftsmanship was the vision behind the cockpit. High-back bolstered seats offer greater thigh, lumbar and lateral support to enhance your in-control feel. Contrast stitching<sup>1</sup> found on the leather-wrapped steering wheel and shifter complement the contact points of your hand, while available semi-aniline leather appointments<sup>1</sup> provide durable and soft seating surfaces. Dual screen displays are ergonomically positioned to relay information and make for easy driver input. This is an exclusive space for drivers, capturing the spirit of a premium sport coupe.

▼ **IN SYNC WITH YOUR LIFE** INFINITI InTouch™ with wireless Apple CarPlay® lets you bring the iPhone® experience along for the ride without plugging in. Or make your Android Auto™ compatible phone your



INFINITI InTouch™ featuring wireless Apple CarPlay™ integration<sup>2</sup>

preferred driving companion.<sup>3</sup> Navigation provides real-time Traffic information, turn-by-turn directions and more.<sup>3,4</sup> Finally, enhanced Wi-Fi capability transforms your Q60 into a high-speed hotspot.<sup>3</sup>



Bose® Performance Series Audio with Bose® CenterPoint™ surround technology

**EVOLVE YOUR DRIVE** INFINITI drive assist technologies were engineered to help increase peace of mind. Available systems such as Blind Spot Warning and Lane Departure Warning can alert you to potential hazards.<sup>5,6</sup> Driving aids, such as Intelligent Cruise Control (Full-Speed Range) can automatically adjust your speed to the flow of traffic.<sup>1,7</sup> In the ProACTIVE Package, Lane Departure Prevention, Blind Spot Intervention® and Active Lane Control, utilize automated steering input to help you stay in your lane.<sup>1,5,6,8</sup> Innovations like these help make the driving experience as enlightening as it is engaging.

**HANDLING IS PERSONAL** With two steering and two suspension systems, the path to agility is yours to customize. Select either Electronic Power Steering with Sport mode for a lively response. Or go digital with Direct Adaptive Steering,<sup>9</sup> on the ProACTIVE Package, and feel how easy it is to carve a perfect turn.<sup>1</sup> The choice of suspension is equally empowering. Independent front and rear suspension gives you a smooth level ride while Dynamic Digital Suspension, on Q60 RED SPORT 400,<sup>1</sup> recalibrates the balance between comfort and performance electronically as adjustable dampers react in real time to changing road demands and driver input.



# TRIM LEVELS & PACKAGES

## Q60 PURE

### MECHANICAL AND PERFORMANCE

- 3.0-liter twin-turbocharged V6 engine (300 hp @ 6,400 rpm, 295 lb-ft @ 1,600–5,200 rpm)
- 7-speed automatic transmission
- Manual shift mode with Downshift Rev Matching
- Electronic Power Steering
- Rear-Wheel Drive or INFINITI Intelligent All-Wheel Drive<sup>9</sup>

### DESIGN

- LED automatic-on/off headlights
- LED signature Daytime Running Lights
- LED signature taillights
- LED front fog lights
- 19-inch aluminum-alloy wheels with 255/40R19 run-flat, all-season tires
- Zero-lift aerodynamics
- Front door handle courtesy lights

### CRAFTSMANSHIP

- Leatherette seating
- Brushed Aluminum interior trim
- Front door aluminum INFINITI kick plates
- 8-way power adjustable front seats

### TECHNOLOGY

- INFINITI InTouch™ dual HD display system<sup>3</sup>
- INFINITI InTouch™ Services<sup>3</sup>
- Wireless Apple CarPlay® integration<sup>3</sup>
- Android Auto™<sup>3</sup>
- SiriusXM® Radio with Advanced Audio Features with 3-month trial access<sup>3</sup>
- Streaming Audio via Bluetooth®<sup>3</sup>
- 1 USB Type-A and 1 USB Type-C ports<sup>10</sup>
- Wi-Fi Hotspot<sup>3</sup>
- Dual Zone Automatic Temperature Control System
- INFINITI Intelligent Key with Push Button Start
- INFINITI Voice Recognition<sup>4</sup>
- Enhanced Intelligent Key memory stores audio, climate control and driving preferences
- INFINITI Drive Mode Selector
- Rain-sensing wipers

### SAFETY

- RearView Monitor<sup>11</sup>
- Anti-lock Braking System
- Brake Assist<sup>12</sup>
- Electronic Brake force Distribution
- Vehicle Dynamic Control<sup>13</sup> with Traction Control System
- Tire Pressure Monitoring System<sup>14</sup>
- Vehicle Security System

## Q60 LUXE

Includes all Q60 PURE standard features, plus:

### DESIGN

- Power sliding/tinted glass moonroof and sliding sunshade
- Semi-aniline leather-appointed seats
- Driver's seat power lumbar and side bolsters
- Heated front seats and steering wheel
- Aluminum accented sport pedals

### TECHNOLOGY

- Front and Rear Sonar System<sup>15</sup>
- Intelligent Cruise Control (Full-Speed Range)<sup>7</sup>
- Distance Control Assist<sup>16</sup>
- Bose® Performance Series Audio 13-speaker stereo with Bose® CenterPoint® simulated surround
- HomeLink® Universal Transceiver
- Auto-dimming rearview mirror with compass
- Remote Engine Start<sup>17</sup>

### SAFETY

- Forward Emergency Braking with pedestrian detection<sup>18</sup>
- Predictive Forward Collision Warning<sup>19</sup>
- Around View® Monitor with Moving Object Detection<sup>20</sup>
- Blind Spot Warning<sup>5</sup>
- Backup Collision Intervention<sup>21</sup>
- Lane Departure Warning<sup>6</sup>
- Haptic Steering Wheel
- High Beam Assist headlights

Optional Package: **1**

## Q60 RED SPORT 400

Includes all Q60 LUXE standard features, plus:

### MECHANICAL AND PERFORMANCE

- 3.0-liter twin-turbocharged V6 engine (400 hp @ 6,400 rpm, 350 lb-ft @ 1,600–5,200 rpm)
- Dynamic Digital Suspension
- Sport brakes with red finish calipers

### DESIGN

- 20-inch staggered aluminum-alloy sport wheels<sup>1</sup>
- Red "S" exterior badging
- Unique dual exhaust tips with brushed satin finish
- Steering wheel-mounted paddle shifters
- Black-painted front grille surround, fender vent and side mirrors

### CRAFTSMANSHIP

- Genuine Matte Black Carbon Fiber interior trim
- Exclusive Dark Chrome interior accents
- Dashboard with red contrast stitching
- Shifter with red contrast stitching

### TECHNOLOGY

- Navigation with 3D building graphics, 5-year complimentary access to Premium Traffic and MapCare<sup>3,4</sup>
- INFINITI Voice Recognition for navigation functions<sup>4</sup>
- SiriusXM® Travel Link® with 3-month trial access to weather, fuel prices, stock prices, sports scores, movie listings and parking<sup>3</sup>

- SiriusXM® Traffic™ with 3-month trial access to real-time traffic information<sup>3</sup>
  - Dual-occupant memory system for driver's seat, steering column and outside mirrors
  - Power tilt and telescoping steering column
  - Power folding, auto-dimming outside mirrors with reverse tilt-down feature
  - Advanced Climate Control System with auto-recirculation, Plasmacluster® air purifier and Grape Polyphenol Filter<sup>22</sup>
- Optional Package: **2**



## PACKAGES

### 1 ESSENTIAL PACKAGE

- Navigation with 3D building graphics, 5-year complimentary access to Premium Traffic and MapCare<sup>3,4</sup>
- INFINITI Voice Recognition for navigation functions<sup>4</sup>
- SiriusXM® Traffic™ with 3-month trial access to real-time traffic information<sup>3</sup>
- SiriusXM® Travel Link® with 3-month trial access to weather, fuel prices, stock prices, sports scores, movie listings and parking<sup>3</sup>
- Power tilt and telescoping steering wheel column
- Advanced Climate Control System with auto-recirculation, Plasmacluster® air purifier and Grape Polyphenol Filter<sup>22</sup>
- Dual-occupant memory system for driver's seat, steering column and outside mirrors
- Power folding, auto-dimming outside mirrors with reverse tilt-down feature

### 2 PROACTIVE PACKAGE

- Direct Adaptive Steering®
- Blind Spot Intervention<sup>5</sup>
- Lane Departure Prevention<sup>6</sup>
- Active Lane Control<sup>8</sup>
- Adaptive Front Lighting System
- Front-seat Pre-Crash Seat Belts
- Eco Pedal<sup>23</sup>

Build your vehicle at  
infinityusa.com





1 CARBON FIBER REAR DECK LID SPOILER 2 CARBON FIBER MIRROR COVERS

**^ EXTERIOR** Style without pretense. Carbon Fiber elevates the aggressive character and gives the Q60 a more dynamic look. Select a custom-designed Carbon Fiber Rear Deck Lid Spoiler and you're adding a distinctive design element that also gives the rear a streamlined appearance. Carbon Fiber Mirror Covers were designed to integrate smoothly with the turn signal indicators for a high-tech look and feel.

**v INTERIOR** Take life with you. A Console Net allows you to keep a tablet close by, while Sport Floor Mats embrace your performance nature with a specially placed rubber section to save on heels. For those who won't let weather keep you indoors or off the roads, All-Season Floor Mats will help keep your interior pristine.



3 CONSOLE NET  
4 ALL-SEASON, SPORT, AND CARPETED FLOOR MATS  
5 INFINITI RADIANT ILLUMINATED KICK PLATES AND INFINITI RADIANT EXTERIOR WELCOME LIGHTING

**^ LIGHTING** Illuminate elegance with signature lighting accessories. The effect lends an upscale ambience and offers a modern appeal that is unmistakable. From the soft glow of the INFINITI logo along the front door sills to the drama of INFINITI Radiant Exterior Welcome Lighting, brilliance is all around. Turn it on.



# ACCESSORIES FOR MORE POSSIBILITIES

Whether you're protecting your investment or adding a convenience feature, a few choice additions can help you get the most out of your Q60. We ensure that each Genuine INFINITI Accessory<sup>24</sup> is designed and manufactured to integrate seamlessly with your vehicle and provide a custom fit and finish. For more information and to shop online for Genuine INFINITI Accessories, go to [parts.infiniti.com](http://parts.infiniti.com).

ACCESSORIES SHOWN: 20-INCH CHARCOAL METALLIC PERFORMANCE WHEELS AND CARBON FIBER FENDER VENTS KIT.

**v CARGO** Use a Cargo Net to help keep items in the trunk from shifting around, while Shopping Bag Hooks allow for quick placement and retrieval of your hand bag or grocery bag. The durable Trunk Area Protector guards against spills, damage, and wear and tear.<sup>25</sup>



1 TRUNK AREA PROTECTOR AND REAR CARGO NET<sup>25</sup> 2 SHOPPING BAG HOOKS

**ADDITIONAL ACCESSORIES TO CONSIDER:**  
Door Edge Protectors  
Carbon Fiber Front Fog Light Surround Kit  
INFINITI Radiant Interior Ambient Lighting  
19-inch Charcoal Metallic Performance Wheel

# TECHNICAL SPECS

## PERFORMANCE

PURE, LUXE – horsepower / torque	300 hp / 295 lb-ft
RED SPORT 400 – horsepower / torque	400 hp / 350 lb-ft
Suspension – front / rear	Double-wishbone / Independent multi-link
Available Sport Suspension	Dynamic Digital Suspension
Available Sport Brakes rotor size – front / rear (inches)	14.0 / 13.8

## INTERIOR DIMENSIONS

Trunk volume <sup>25</sup> (cubic feet)	8.7
Front head room – with / without moonroof (inches)	37.4 / 37.9

## FUEL ECONOMY

Estimated Fuel Economy PURE, <sup>26</sup> LUXE <sup>26</sup>   RED SPORT 400 <sup>27</sup> RWD (city / highway / combined)	19 / 28 / 22   20 / 27 / 22
Estimated Fuel Economy PURE, <sup>28</sup> LUXE <sup>28</sup>   RED SPORT 400 <sup>29</sup> AWD (city / highway / combined)	19 / 27 / 22   19 / 26 / 21

See infinitiusa.com for complete list of specifications.

\*Q60 PURE, Q60 LUXE, Q60 RED SPORT 400. \*\*Q60 PURE AWD, Q60 LUXE AWD, Q60 RED SPORT 400 AWD.

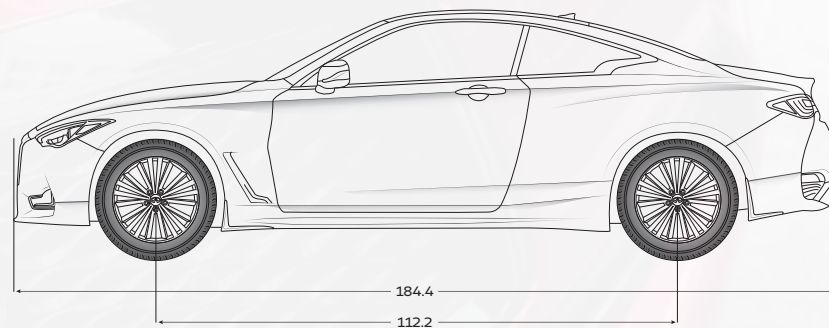
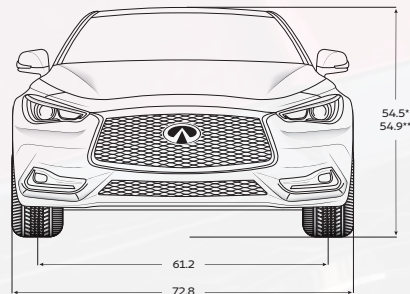

All dimensions are measured in inches.

<sup>1</sup>Available on select models. <sup>2</sup>Q60 RED SPORT 400 AWD receives 20 x 9.0-inch front and rear wheels with all-season performance tires. <sup>3</sup>Available feature shown. Use feature only when safe and legal. Compatible device and service required. Subject to third party service availability. For more information see [www.infiniti.com/intouch/legal](http://www.infiniti.com/intouch/legal). <sup>4</sup>Never program while driving. GPS mapping may not be detailed in all areas or reflect current road status. <sup>5</sup>Blind Spot Warning and Blind Spot Intervention<sup>®</sup> cannot prevent all collisions and may not detect every object or warn in all situations. Driver should always turn and look before changing lanes. See Owner's Manual for safety information. <sup>6</sup>Lane Departure Prevention and Lane Departure Warning only operate when lane markings are detectable. See Owner's Manual for safety information. <sup>7</sup>Intelligent Cruise Control uses limited braking and is not a collision avoidance or warning system. Driver should monitor traffic conditions and brake as needed to prevent collisions. See Owner's Manual for safety information. <sup>8</sup>Active Lane Control cannot prevent collisions or loss of control. Driver should remain in control of vehicle at all times. See Owner's Manual for safety information. <sup>9</sup>Intelligent All-Wheel Drive cannot prevent collisions or provide enhanced traction in all conditions. Always monitor traffic and weather conditions. <sup>10</sup>Driving is serious business and requires your full attention. If you have to use the connected device while driving, exercise extreme caution at all times so full attention may be given to vehicle operation. <sup>11</sup>Rear View Monitor may not detect every object and does not eliminate blind spots or warn of moving objects. See Owner's Manual for safety information. <sup>12</sup>Brake Assist cannot prevent all collisions and may not provide warning or braking in all conditions. Driver should monitor traffic conditions and brake as needed to prevent collisions. See Owner's Manual for safety information. <sup>13</sup>Vehicle Dynamic Control cannot prevent collisions due to abrupt steering, carelessness, or dangerous driving technique. It should remain on when driving, except when freeing the vehicle from mud or snow. See Owner's Manual for safety information. <sup>14</sup>Tire Pressure Monitoring System is not a substitute for regular tire pressure checks. See Owner's Manual for safety information. <sup>15</sup>Sonar System may not detect every object. Driver should always check surroundings before driving. See Owner's Manual for safety information. <sup>16</sup>Distance Control Assist uses limited braking and is not a collision avoidance or warning system. Driver should monitor traffic conditions and brake as needed to prevent collisions. See Owner's Manual for safety information. <sup>17</sup>Remote Engine Start System to be used only in accordance with any laws or rules in effect in your vehicle's location. <sup>18</sup>Forward Emergency Braking with pedestrian detection cannot prevent all collisions and may not provide warning or braking in all conditions. Driver should monitor traffic conditions and brake as needed to prevent collisions. See Owner's Manual for safety information. <sup>19</sup>Predictive Forward Collision Warning cannot prevent collisions. See Owner's Manual for safety information. <sup>20</sup>Around View<sup>®</sup> Monitor with Moving Object Detection cannot eliminate blind spots and may not detect every object. Driver should always turn and check surroundings before driving. See Owner's Manual for safety information. <sup>21</sup>Backup Collision Intervention may not detect every object. Driver should always turn and check surroundings before driving. See Owner's Manual for safety information. <sup>22</sup>The Advanced Climate Control System with Plasmacluster air purifier helps scrub the air in the vehicle's interior. The system can sense exterior odors, can suppress unpleasant interior odors, can stop the inflow of external odors and helps keep the cabin smelling fresh, but does not always eliminate odors. <sup>23</sup>Monitor traffic conditions and use conventional brake as needed to prevent collisions. See Owner's Manual for safety information. <sup>24</sup>Genuine INFINITI Accessories are covered by INFINITI's limited warranty on Genuine INFINITI Replacement Parts, and Genuine INFINITI Accessories for the longer of 12 months/12,000 miles (whichever occurs first) or the remaining period under the 48 months/60,000-mile (whichever occurs first) new vehicle limited warranty. Terms and conditions apply. See retailer, warranty information booklet, or [parts.infiniti.com](http://parts.infiniti.com) for details. <sup>25</sup>Cargo and load capacity limited by weight and distribution. Always secure all cargo. <sup>26</sup>2022 Q60 RWD EPA Fuel Economy Estimates 19 mpg City, 28 mpg Highway. Actual mileage may vary with driving conditions. Use for comparison only. <sup>27</sup>2022 Q60 RED SPORT 400 RWD EPA Fuel Economy Estimates 20 mpg City, 27 mpg Highway. Actual mileage may vary with driving conditions. Use for comparison only. <sup>28</sup>2022 Q60 AWD EPA Fuel Economy Estimates 19 mpg City, 27 mpg Highway. Actual mileage may vary with driving conditions. Use for comparison only. <sup>29</sup>2022 Q60 RED SPORT 400 AWD EPA Fuel Economy Estimates 19 mpg City, 26 mpg Highway. Actual mileage may vary with driving conditions. Use for comparison only. <sup>30</sup>Android<sup>®</sup> and Android Auto<sup>™</sup> are trademarks of Google LLC. Bluetooth<sup>®</sup> is a registered trademark of Bluetooth SIG, Inc. Bose<sup>®</sup> and CenterPoint<sup>®</sup> are registered trademarks of The Bose Corporation. Apple CarPlay<sup>®</sup> is a registered trademark of Apple Inc. HomeLink<sup>®</sup> is a registered trademark of Genex Corporation. iPhone<sup>®</sup> is a registered trademark of Apple Inc. All rights reserved. iPhone<sup>®</sup> or other external device not included. The Sirius<sup>®</sup>, XM<sup>®</sup>, and SiriusXM<sup>®</sup> names and all related marks and logos are trademarks of Sirius XM Radio Inc. All other trademarks are the property of their respective owners.

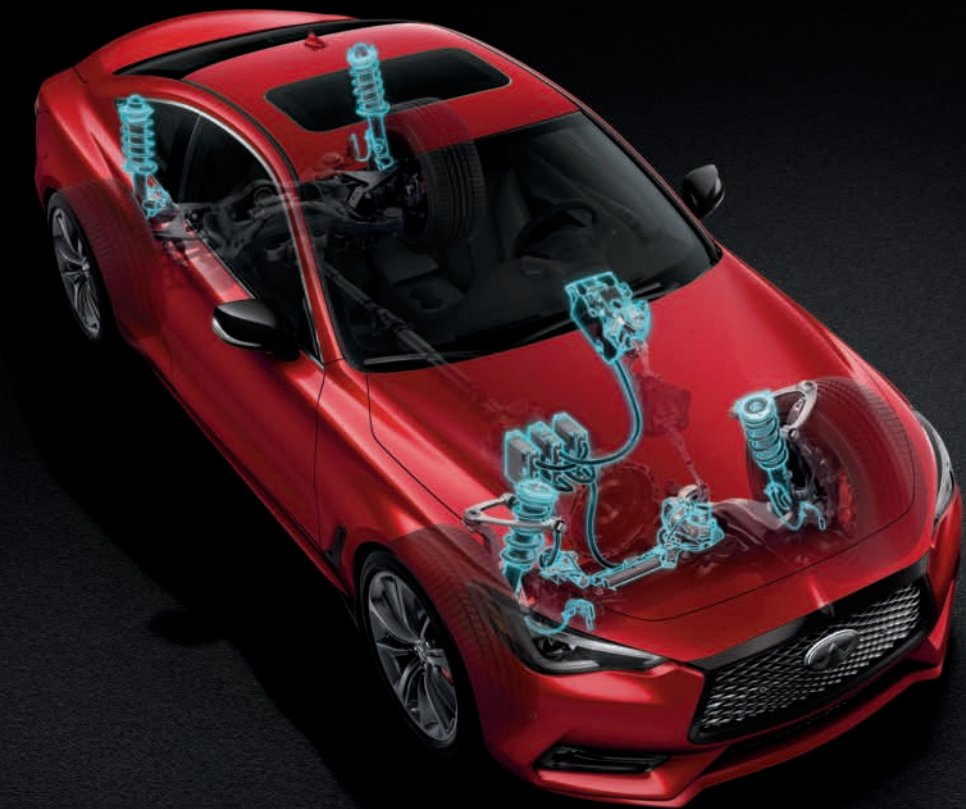

# SYSTEM PREFERENCES

## PERFORMANCE ON YOUR TERMS

### ^ EQUIPPED TO ENTHRALL

The three-spoke steering wheel in the Q60 RED SPORT 400 features shift paddles for manual gear selection. The available Direct Adaptive Steering<sup>®</sup> system can adjust steering response to suit driving conditions. Large 14.0-inch front and 13.8-inch rear brake discs help improve braking performance.<sup>1</sup>

Equipped with advanced suspension, steering and drive mode systems, the Q60 RED SPORT 400 allows drivers to fine-tune the performance to their liking. The drive mode selector allows drivers to choose from a menu of settings that include: Standard, Sport, Sport+, Personal, Eco and Snow. Sport and Sport+ modes offer higher engine output and dial up the suspension, steering and transmission settings for performance driving. The Personal mode allows the driver to create a custom setting profile. The Eco mode helps reduce fuel consumption through the modulation of accelerator pedal pressure, while the Snow mode helps reduce traction loss in inclement weather.<sup>1</sup>